

DETAIL B  
SCALE 1 : 2

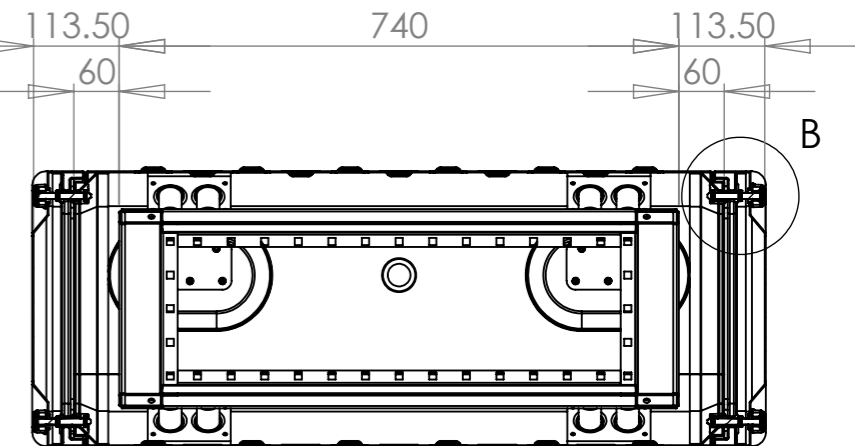
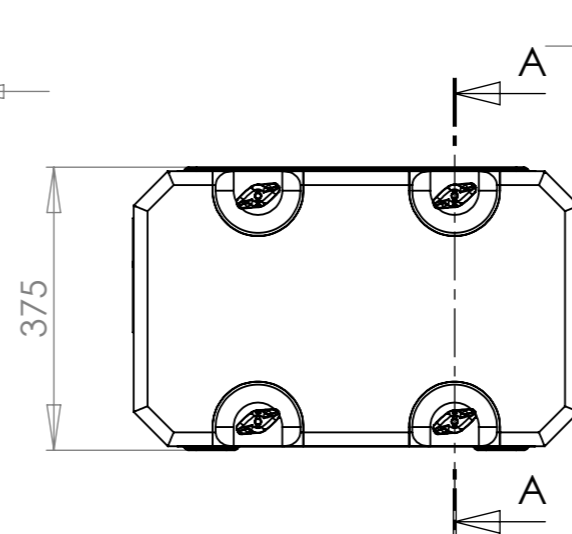
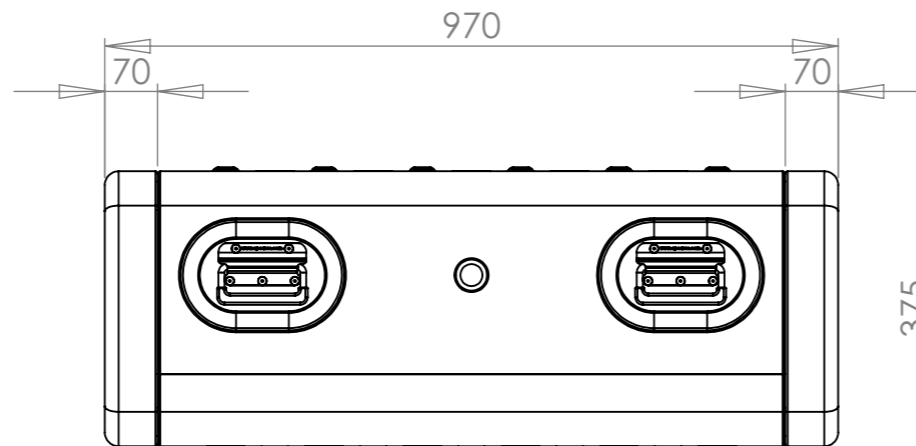
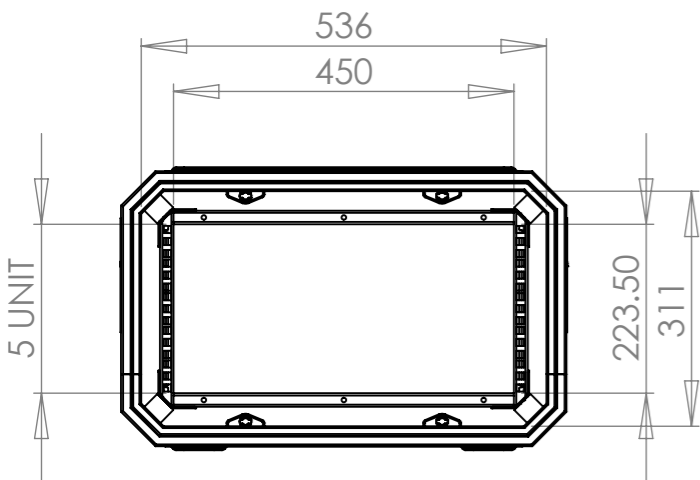

SECTION A-A

<b>Nato Stock No (NSN)</b>				<b>Moulding Tolerance +/- (1%+1mm)</b>			<b>Title</b>			<b>Drg. No.</b>	
N/A				<b>External Dimensions (mm)</b>			E-Rack RR0574-0707			RR0574-0707	
<b>Options Available</b>	<b>Option Selected</b>	<b>Qty</b>	<b>Part #</b>	<b>Height</b>	<b>Width</b>	<b>Depth</b>	<b>Drawn By</b>	<b>Date</b>	<b>Sheet No.</b>	<b>Issue No.</b>	
				375	589	970	MW	17/09/2010	1 Of 1	02	
				<b>Rack Size (U)</b>		05	<b>Dimensions In Millimeters</b>		<b>Third Angle Projection</b>		
				<b>Frame Depth (mm)</b>		740	<b>Do Not Scale</b>				

**CP Cases Ltd.**

Worton Hall Industrial Estate, Worton Road,  
Isleworth, Middlesex, TW7 6ER, UK.  
Tel: +44 (0) 20 8568 1881 Fax: +44 (0) 20 8568 1141  
Email: amazon@cpcases.com Website: www.cpcases.com

Copyright CP Cases Limited.  
This drawing is the property of CP Cases Limited & the information on it is confidential & it is not to be used for any other purpose without the prior written consent of CP Cases Limited.