

DETAIL B
SCALE 1 : 2

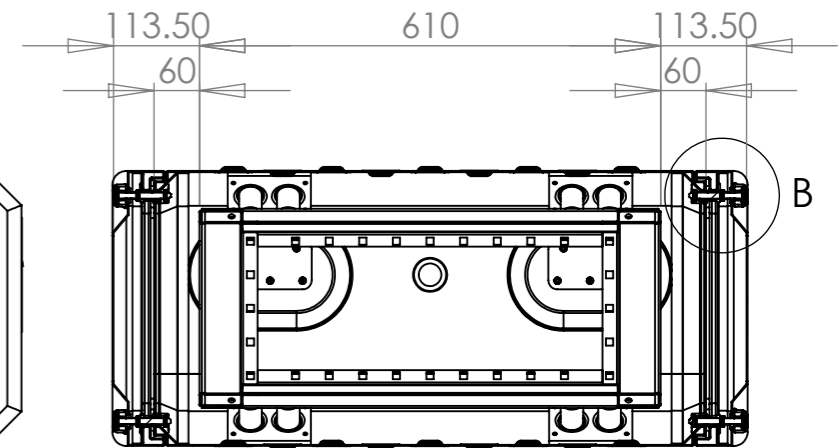
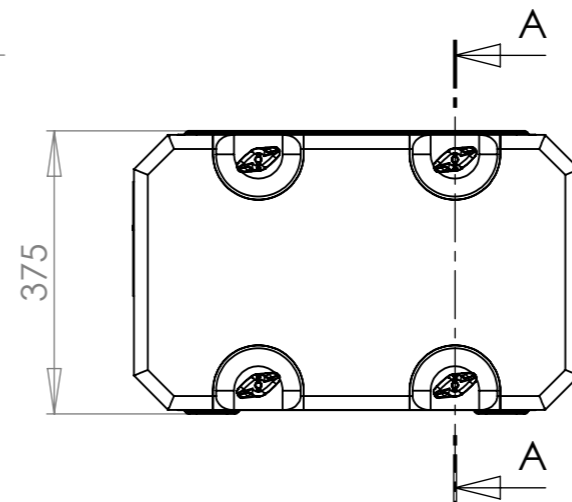
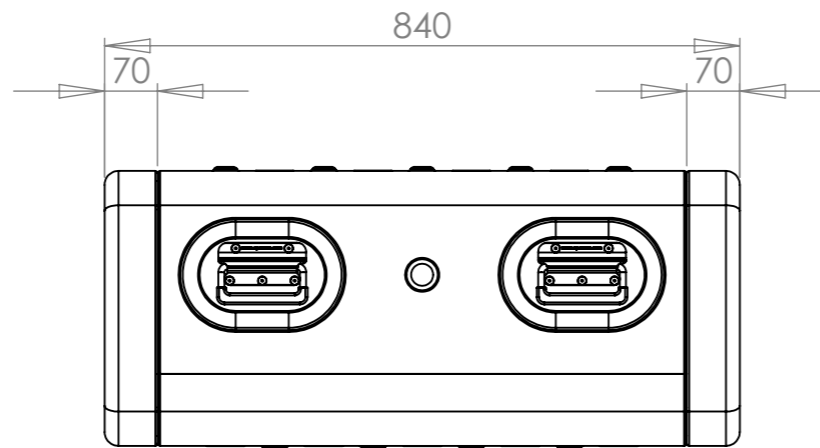
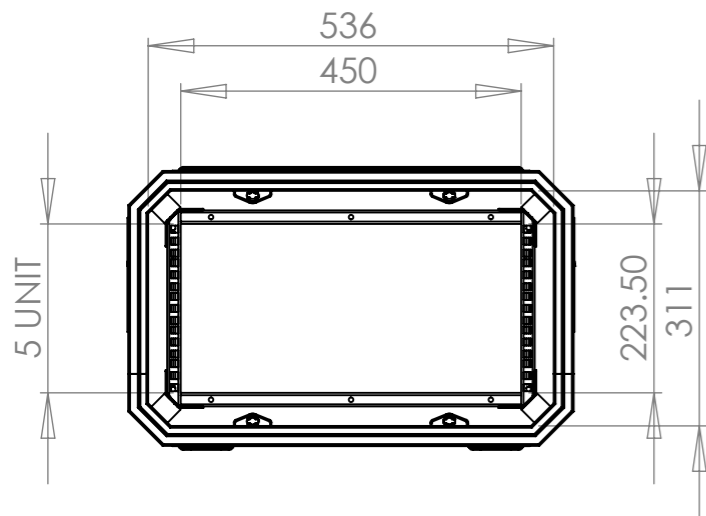

SECTION A-A

Options Available	Part #	General Tolerance +/- (1%+1mm)			Title			Drg. No.	
		External Dimensions (mm)			E-Rack RR0561-0707			RR0561-0707	
		Height	Width	Depth	Drawn By	Date	Sheet No.	Issue No.	
		375	589	840	MW	17/09/2010	1 Of 1	02	
		Rack Size (U)		05	Dimensions In Millimeters		Third Angle Projection		
		Frame Depth (Inches)		610	Do Not Scale				

CP Cases Ltd.

Worton Hall Industrial Estate, Worton Road,
Isleworth, Middlesex, TW7 6ER, UK.
Tel: +44 (0) 20 8568 1881 Fax: +44 (0) 20 8568 1141
Email: info@cpcases.com Website: www.cpcases.com

Copyright CP Cases Limited.
This drawing is the property of CP Cases Limited & the information on it is confidential & it is not to be used for any other purpose without the prior written consent of CP Cases Limited.