

DETAIL B
SCALE 1 : 2

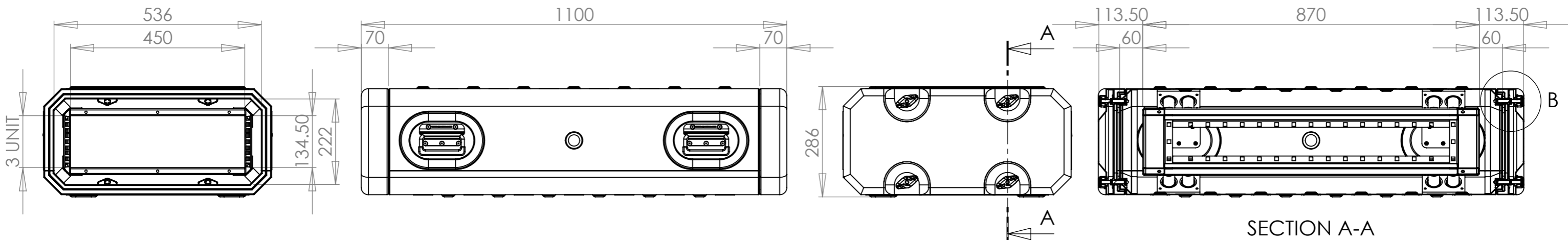
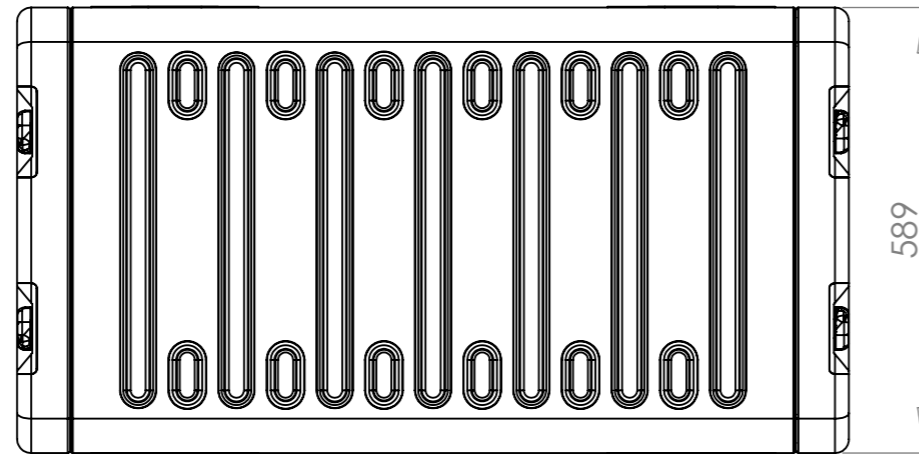

SECTION A-A

Nato Stock No (NSN)			Moulding Tolerance +/- (1%+1mm)			Title			Drg. No.	
N/A			External Dimensions (mm)			E-Rack RR0387-0707			RR0387-0707	
Options Available	Option Selected	Qty	Part #	Height	Width	Depth	Drawn By	Date	Sheet No.	Issue No.
				286	589	1100	MW	17/09/2010	1 Of 1	02
				Rack Size (U)	03		Dimensions In Millimeters		Third Angle Projection	
				Frame Depth (mm)	870		Do Not Scale			

CP Cases Ltd.

Worton Hall Industrial Estate, Worton Road,
Isleworth, Middlesex, TW7 6ER, UK.
Tel: +44 (0) 20 8568 1881 Fax: +44 (0) 20 8568 1141
Email: amazon@cpcases.com Website: www.cpcases.com

Copyright CP Cases Limited.
This drawing is the property of CP Cases Limited & the information on it is confidential & it is not to be used for any other purpose without the prior written consent of CP Cases Limited.